

## LB117F 传感压力表

## LB117F Sensored Pressure gauge

## Description

LB117F 是一款线性输出传感表，输出是基于额外补偿的机械系统。

常应用于腐蚀性大气、振动和脉动环境、食品工厂、水设施、医疗。

LB117F is linear volt output, the output is based on a mechanical system with extra compensation.

Applications in corrosive atmospheres, vibration and pulsating environments, and food industry ,water suppliers, medical.



LB117F

## Material Feature

指针 Pointer:	PA66+30%GF	防护等级 Protection:	IP67
机芯 Movement:	不锈钢 SS304	外壳 Case:	不锈钢 304, 抛光 SS304, Polished
表径 Diameter:	500mm	表圈 Ring:	不锈钢 304, 抛光 SS304, Polished
标牌 Dial:	塑料 Plastic	接头 Connection:	不锈钢 SS316 NPT/BSP/BSPT/Metric
表面 Window:	聚碳酸酯 Polycarbonate	弹簧管 Bourdon Tube:	不锈钢 SS316L
填充液 Filling Liquid:	甘油 Glycerine	压力范围 Pres. Range:	VAC~9PSI~15000PSI
精度 Accuracy:	机械信号 Mechanical: 1.6%/1.0%* 电信号 Electrical: 1.0%/0.6%*		
*可按要求提供 * Available under request			

## Dimensions

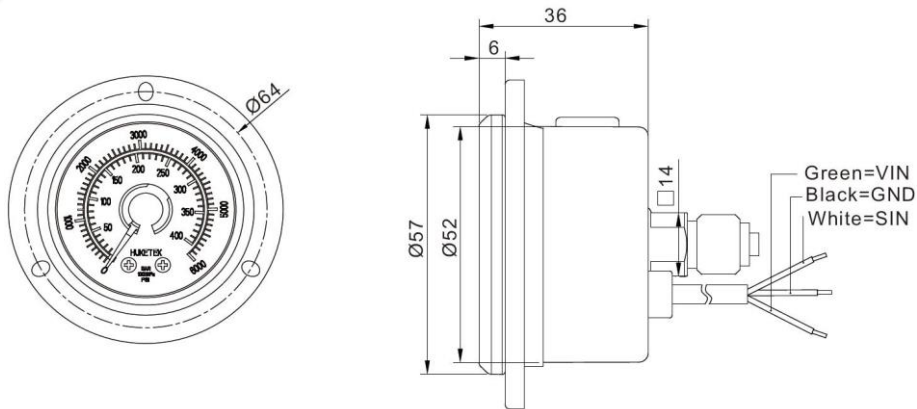





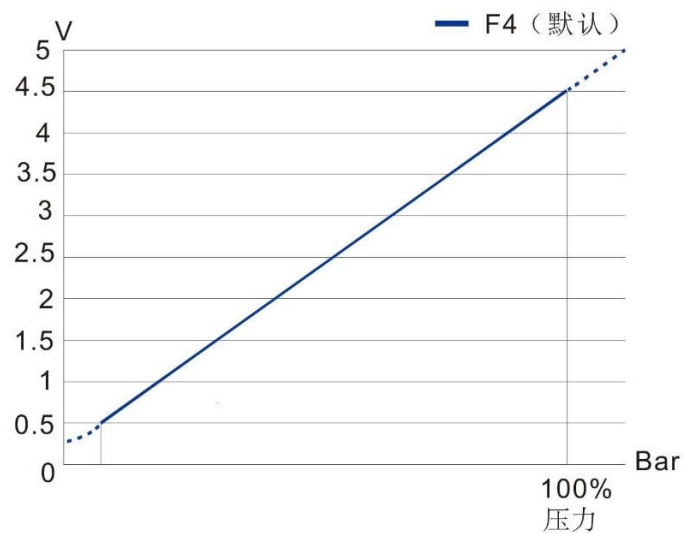

## Output types

信号类型 (可定制) Signal Type (Can be customized)		
信号 Signal	输入 Input	输出 Output
<b>F4</b> (默认 Default)	<b>5v</b>	<b>0bar/0.50v~F.S./4.50v</b>
F5	5v	0bar/0.25v~F.S./4.15v
F6	5v	0bar/0.25v~F.S./4.75v
F7	5v	0bar/0.50v~F.S./4.41v
T4	9~24v	0bar/0.50v~F.S./4.50v
T5	9~24v	0bar/0.25v~F.S./4.15v
T6	9~24v	0bar/0.25v~F.S./4.75v
T7	9~24v	0bar/0.50v~F.S./4.41v



## Comparison Chart

<b>Function</b>		=		+	
<b>Cost Control</b>		<		+	
	<b>Sensored Pressure Gauge</b>		<b>Pressure Sensor</b>		<b>General Pressure Gauge</b>